

NDP605A/NDP605B, NDP606A/NDP606B

N-Channel Enhancement Mode Power Field Effect Transistor

General Description

These n-channel enhancement mode power field effect transistors are produced using National's proprietary, high cell density, DMOS technology. This very high density process has been especially tailored to minimize on-state resistance, provide superior switching performance, and withstand high energy pulses in the avalanche and commutation modes. These devices are particularly suited for low voltage applications such as automotive and other battery powered circuits where fast switching, low in-line power loss, and resistance to transients are needed.

Features

- 48 and 42 Amp, 50V and 60V, $R_{DS(on)} = 0.025\Omega$ and 0.028Ω
- Critical DC electrical parameters specified at elevated temperature
- Rugged internal source-drain diode eliminates the need for external Zener Diode Transient Suppressor
- 175°C maximum junction temperature rating
- Easily paralleled for higher current applications
- High density cell design (3 million/in²) for extremely low $R_{DS(on)}$
- Lower $R_{DS(on)}$ temperature coefficient

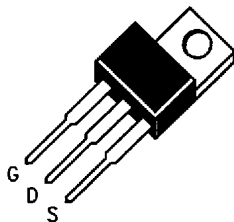

TO-220AB

TL/G/11112-1

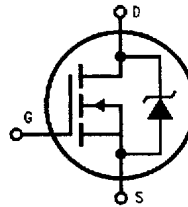

TL/G/11112-2

Absolute Maximum Ratings

Symbol	Parameter	NDP606A	NDP605A	NDP606B	NDP605B	Units
V_{DSS}	Drain-Source Voltage	60	50	60	50	V
V_{DGR}	Drain-Gate Voltage ($R_{GS} = 1\text{ M}\Omega$)	60	50	60	50	V
V_{GSS}	Gate-Source Voltage—Continuous —Non Repetitive ($t_p < 50\ \mu\text{s}$)	± 20 ± 40				V
I_D	Drain Current—Continuous —Pulsed	48 144		42 126		A
P_D	Total Power Dissipation @ $T_C = 25^\circ\text{C}$ Derate Above 25°C	100 0.67				W W/ $^\circ\text{C}$
T_J, T_{STG}	Operating and Storage Temperature Range	-65 to 175				$^\circ\text{C}$
T_L	Maximum Lead Temperature for Soldering Purposes, $1/8$ " from Case for 5 sec.	275				$^\circ\text{C}$

Electrical Characteristics $T_C = 25^\circ\text{C}$ unless otherwise noted							
Symbol	Parameter	Test Conditions	Type	Min	Typ	Max	Units
OFF CHARACTERISTICS							
BV _{DSS}	Drain-Source Breakdown Voltage	V _{GS} = 0V, I _D = 250 μ A	NDP605A NDP605B	50			V
			NDP606A NDP606B	60			V
I _{DSS}	Zero Gate Voltage Drain Current	V _{DS} = Rated Voltage, V _{GS} = 0V, T _J = 25°C	All			250	μ A
			All			1.0	mA
I _{GSSF}	Gate-Body Leakage, Forward	V _{GS} = 20V	All			100	nA
I _{GSSR}	Gate-Body Leakage, Reverse	V _{GS} = -20V	All			-100	nA
ON CHARACTERISTICS							
V _{GS(th)}	Gate Threshold Voltage	V _{DS} = V _{GS} I _D = 250 μ A	All	T _J = 25°C	2.0	4.0	V
				T _J = 125°C	1.4	3.6	V
R _{DS(on)}	Static Drain-Source On-Resistance	T _J = 25°C V _{GS} = 10V	NDP605A NDP606A	I _D = 24A	0.020	0.025	Ω
				I _D = 21A		0.028	Ω
		T _J = 125°C V _{GS} = 10V	NDP605A NDP606A	I _D = 24A	0.030	0.038	Ω
				I _D = 21A		0.048	Ω
g _{FS}	Forward Transconductance	V _{GS} = 10V, I _D = 0.5 Rated I _D	All	10	18		mhos
DYNAMIC CHARACTERISTICS							
C _{iss}	Input Capacitance	V _{GS} = 0V, V _{DS} = 25V f = 1 MHz	All		1375	1800	pF
C _{rss}	Reverse Transfer Capacitance		All		300	400	pF
C _{oss}	Output Capacitance		All		620	800	pF
SWITCHING CHARACTERISTICS							
t _{D(on)}	Turn-On Delay Time	V _{DD} = 25V, I _D = 0.5 Rated I _D , R _{GEN} = 7.5 Ω V _{GS} = 10V	All		16	30	ns
t _r	Rise Time		All		80	120	ns
t _{D(off)}	Turn-Off Delay Time		All		30	60	ns
t _f	Fall Time		All		55	100	ns
Q _g	Total Gate Charge	V _{DS} = 0.8 Rated V _{DSS} , I _D = Rated I _D , V _{GS} = 10V	All		60		nC
Q _{gs}	Gate-Source Charge		All		6		nC
Q _{gd}	Gate-Drain Charge		All		32		nC

Electrical Characteristics $T_C = 25^\circ\text{C}$ unless otherwise noted (Continued)

Symbol	Parameter	Test Conditions	Type	Min	Typ	Max	Units
SOURCE-DRAIN DIODE CHARACTERISTICS							
I_S	Maximum Continuous Source Current		NDP605A NDP606A			48	A
			NDP605B NDP606B			42	A
I_{SM}	Maximum Pulsed Source Current		NDP605A NDP606A			144	A
			NDP605B NDP606B			126	A
V_{SD}	Diode Forward Voltage	$I_S = 0.5$ Rated I_S $V_{GS} = 0\text{V}$	$T_J = 25^\circ\text{C}$	All		1.3	V
			$T_J = 125^\circ\text{C}$	All		1.2	V
t_{rr}	Reverse Recovery Time	$V_{GS} = 0\text{V}$, $I_S = 0.5$ Rated I_S $di_S/dt = 100\text{ A}/\mu\text{s}$	All		85		ns
I_{rr}	Reverse Recovery Current		All		4.8		A
THERMAL CHARACTERISTICS							
$R_{\theta JC}$	Thermal Resistance, Junction to Case					1.50	$^\circ\text{C}/\text{W}$
$R_{\theta JA}$	Thermal Resistance, Junction to Ambient					62.5	$^\circ\text{C}/\text{W}$

Typical Electrical Characteristics

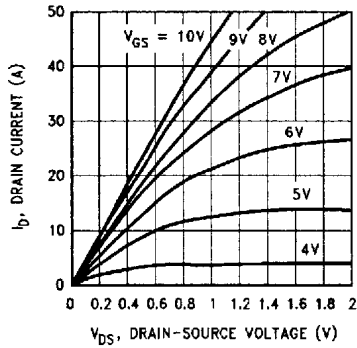

FIGURE 1. On-Region Characteristics

TL/G/11112-3

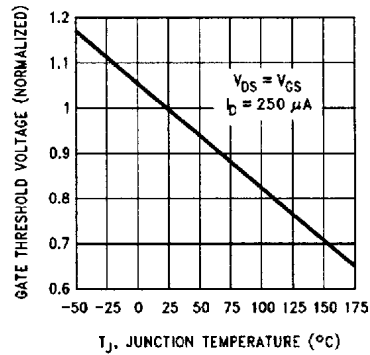

FIGURE 2. Gate Threshold Variation with Temperature

TL/G/11112-4

Typical Electrical Characteristics (Continued)

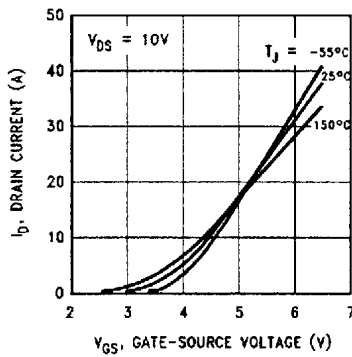

FIGURE 3. Transfer Characteristics

TL/G/11112-5

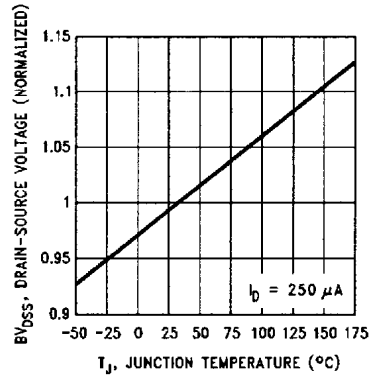

FIGURE 4. Breakdown Voltage Variation with Temperature

TL/G/11112-6

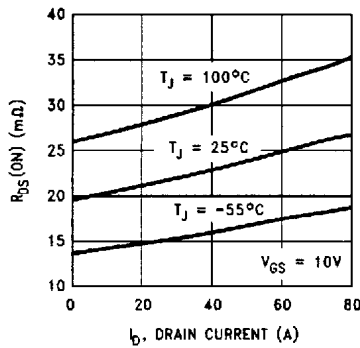

FIGURE 5. On-Resistance versus Drain Current

TL/G/11112-7

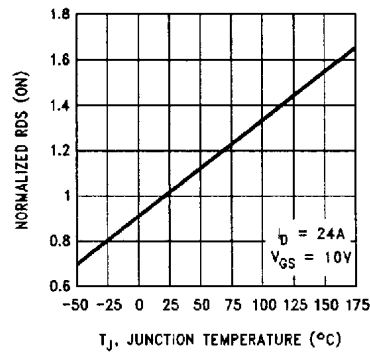

FIGURE 6. On-Resistance Variation with Temperature

TL/G/11112-8

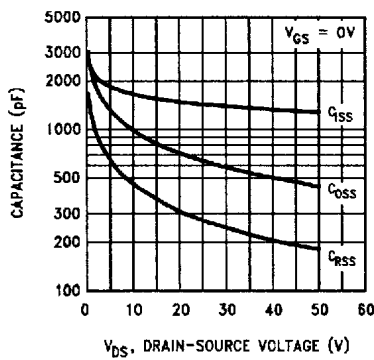

FIGURE 7. Capacitance versus Drain-Source Voltage

TL/G/11112-9

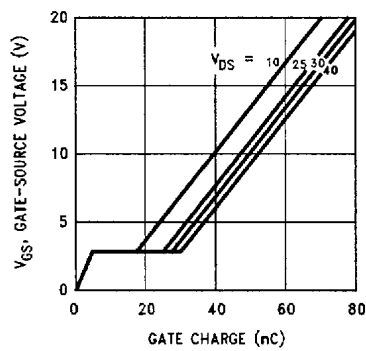

FIGURE 8. Gate Charge versus Gate-Source Voltage

TL/G/11112-10

Typical Electrical Characteristics (Continued)

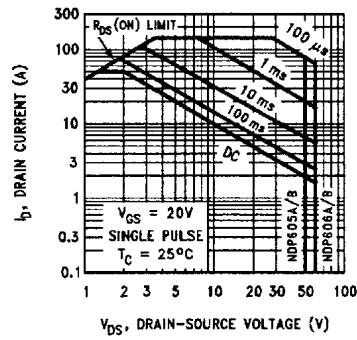

FIGURE 9. Maximum Rated Forward Biased Safe Operating Area

TL/G/11112-11

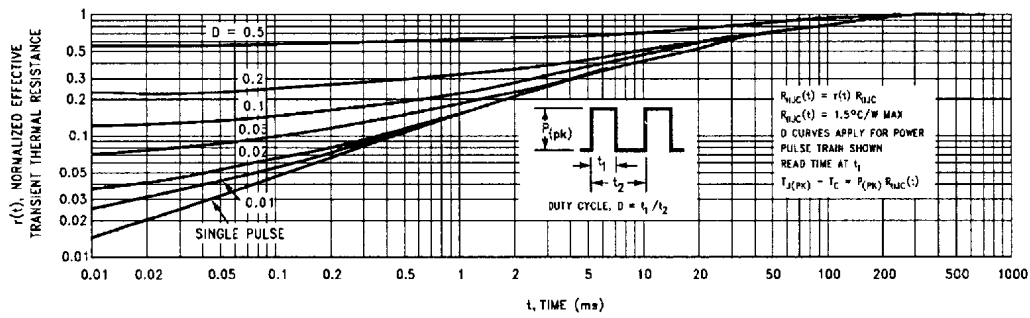

FIGURE 10. Thermal Response

TL/G/11112-12

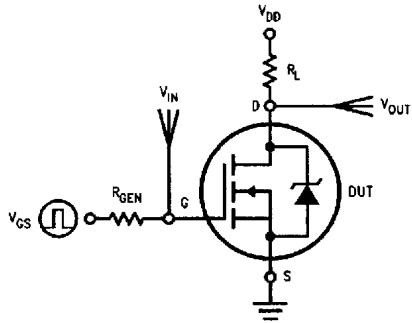

FIGURE 11. Switching Test Circuit

TL/G/11112-13

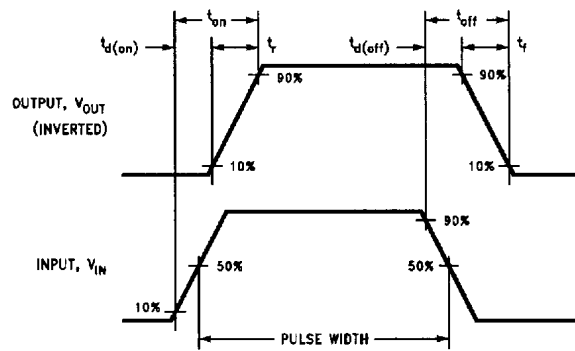
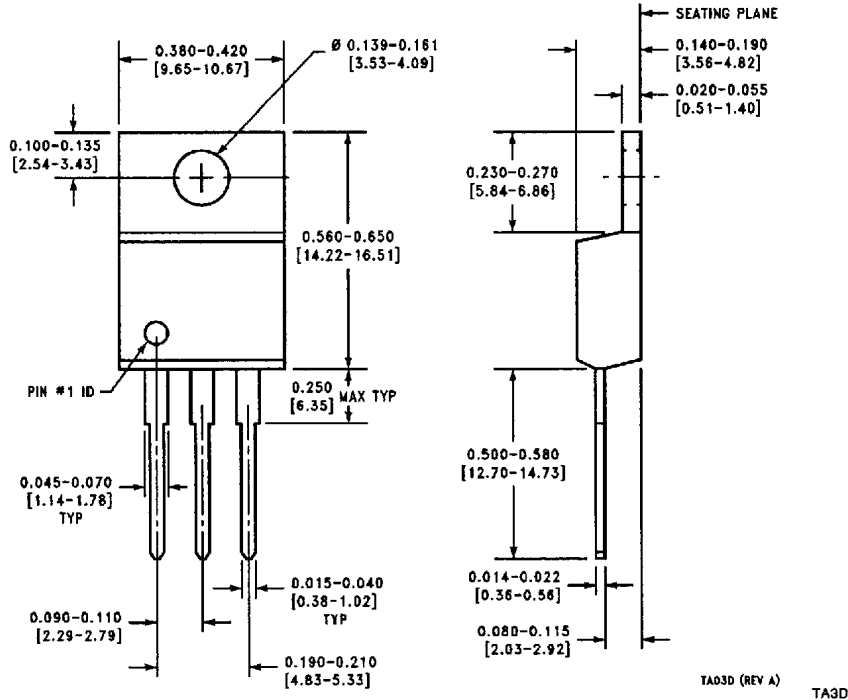

FIGURE 12. Switching Waveforms

TL/G/11112-14

NDP605A/NDP605B, NDP606A/NDP606B
N-Channel Enhancement Mode Power Field Effect Transistor

Package Information



Pin	TO-220
1	Gate
2	Drain
3	Source

LIFE SUPPORT POLICY

NATIONAL'S PRODUCTS ARE NOT AUTHORIZED FOR USE AS CRITICAL COMPONENTS IN LIFE SUPPORT DEVICES OR SYSTEMS WITHOUT THE EXPRESS WRITTEN APPROVAL OF THE PRESIDENT OF NATIONAL SEMICONDUCTOR CORPORATION. As used herein:

1. Life support devices or systems are devices or systems which, (a) are intended for surgical implant into the body, or (b) support or sustain life, and whose failure to perform, when properly used in accordance with instructions for use provided in the labeling, can be reasonably expected to result in a significant injury to the user.
2. A critical component is any component of a life support device or system whose failure to perform can be reasonably expected to cause the failure of the life support device or system, or to affect its safety or effectiveness.



National Semiconductor Corporation
1111 West Bardin Road
Arlington, TX 76017
Tel: 1(800) 272-9959
Fax: 1(800) 737-7018

National Semiconductor Europe
Fax: (+49) 0-180-530 85 86
Email: cnjwgo@tovm2.nsc.com
Deutsch Tel: (+49) 0-180-530 85 85
English Tel: (+49) 0-180-532 78 32
Français Tel: (+49) 0-180-532 93 58
Italiano Tel: (+49) 0-180-534 16 80

National Semiconductor Hong Kong Ltd.
13th Floor, Straight Block,
Ocean Centre, 5 Canton Rd.
Tsimshatsui, Kowloon
Hong Kong
Tel: (852) 2737-1600
Fax: (852) 2736-9960

National Semiconductor Japan Ltd.
Tel: 81-043-299-2309
Fax: 81-043-299-2408

National does not assume any responsibility for use of any circuitry described, no circuit patent licenses are implied and National reserves the right at any time without notice to change said circuitry and specifications.